

← **PRESSURE** →

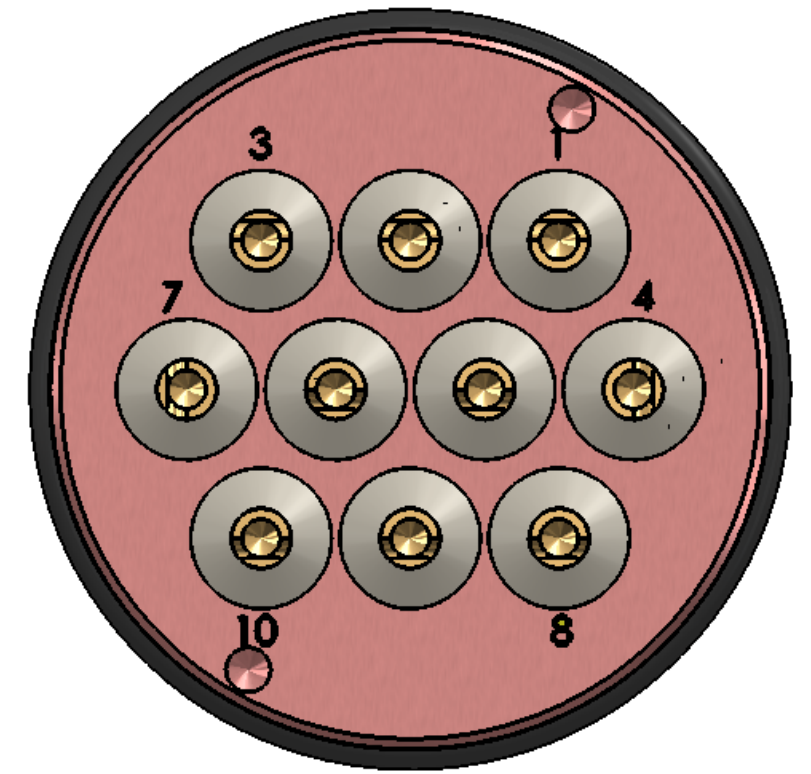

**PROPERTIES:**

1. TEMPERATURE RATING: 392 °F (200 °C)  
CURRENT: 2 AMPS MAX  
INSULATION RESISTANCE = 500M Ω @ 500VDC
2. PRESSURE RATING: 20 KSI
3. CONTACTS ARE GOLD PLATED PER CANYON SPEC: QP-ENG-7.4-001 CURRENT REVISION.

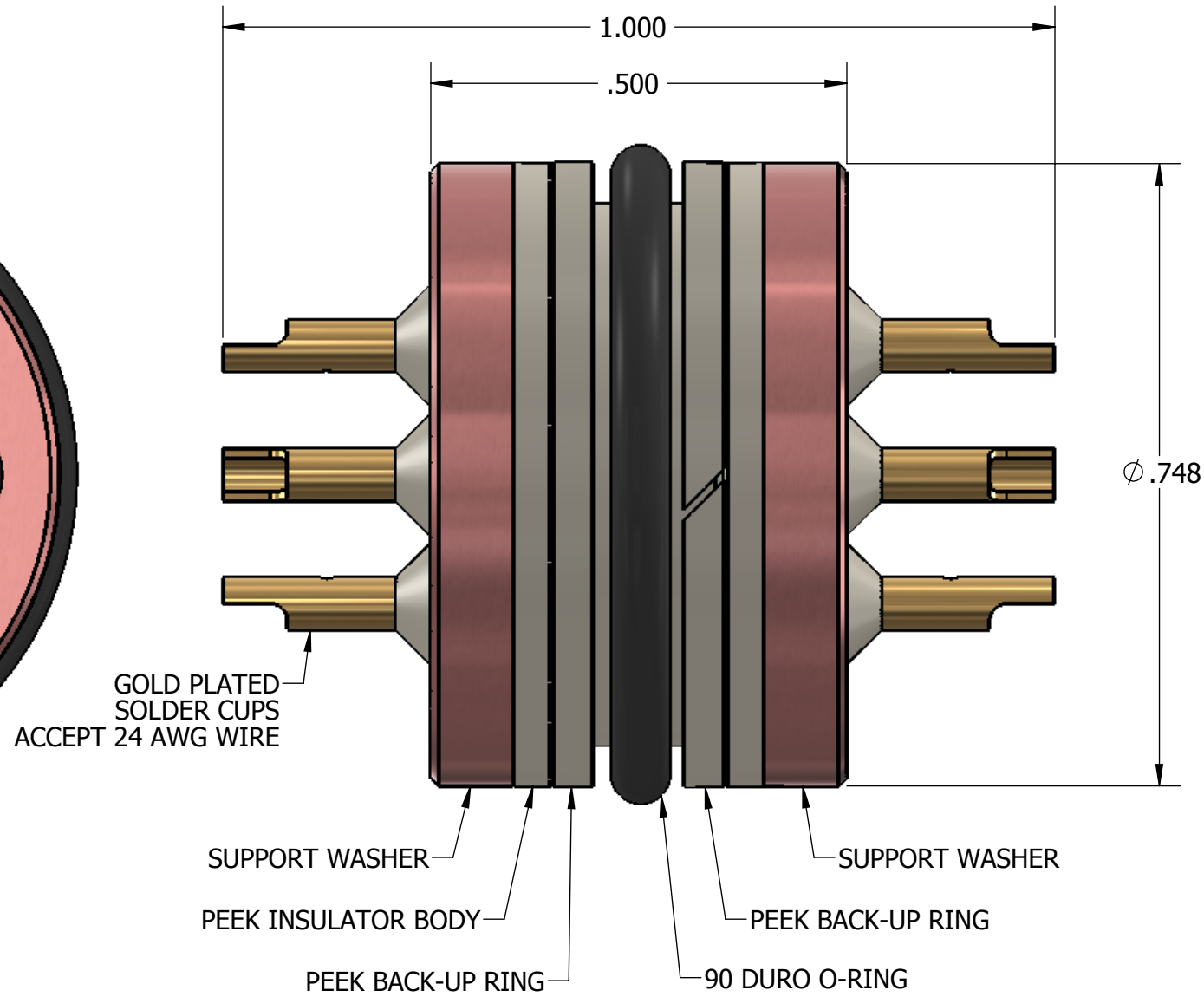
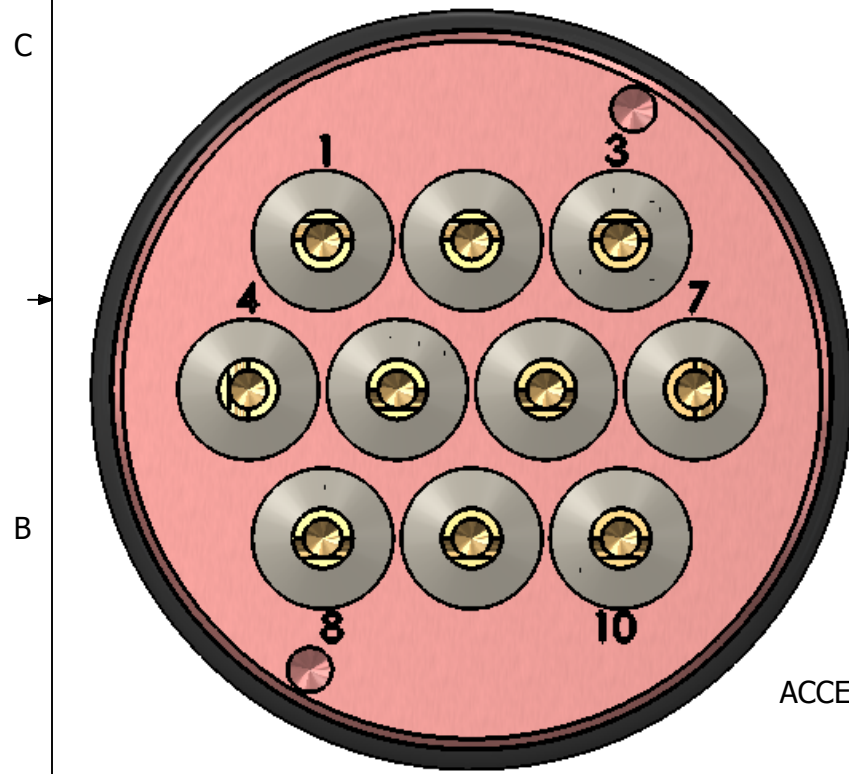

**TITLE:** CONNECTOR, 10 PIN, 24 AWG X 24 AWG SOLDER CUP, .750 DIA, BI-DIRECTIONAL, PIN MOUNT

925-0280-02